

649.20.351.xxx
Concealed wall valve 1/2", body

- clockwise closure
- ceramic discs
- flow rate 17 l/min at 3 bar

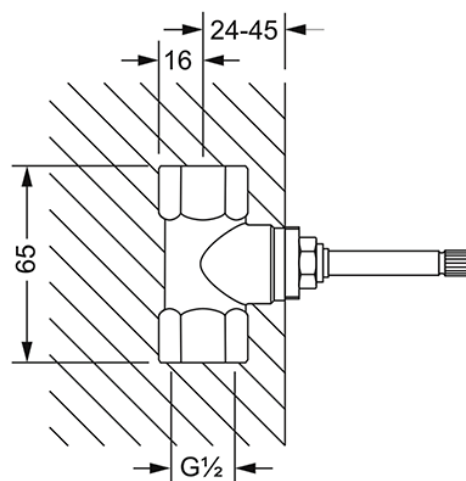

Einbaukörper 1/2"