

649.20.355.000
Concealed wall valve 1/2", body

- counter-clockwise closure
- ceramic discs 1/2"
- flow rate 17 l/min at 3 bar

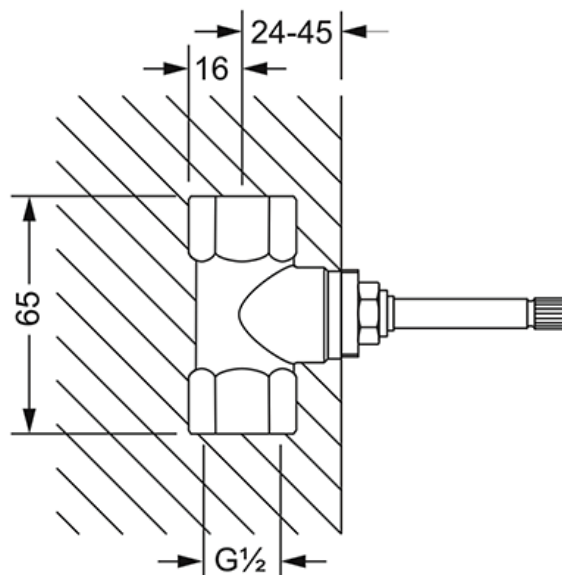

Einbaukörper 1/2"